

# 2010S Integrated Amplifier Quick Start Manual

Thank you for purchasing the Exposure 2010S Integrated Amplifier.

## Before you start

Contents:



Exposure 2010S Integrated Amplifier



Mains cable



HS-101 Exposure System remote control  
(batteries included)



Ensure your unit is switched off and that the volume control knob is at its minimum.



Please note that your 2010S Integrated Amplifier may take up to 48 hours to "run-in" before reaching its optimal performance. Each subsequent "run-in" will then take about 30 minutes.



The Exposure 2010S Integrated Amplifier is fitted with an over current sensor which will switch off the speaker output in the event of a speaker wire short circuit or excessive current. To reset the output, switch off the Amplifier for 5 minutes.

For optimum performance, use Exposure speaker cables with your Exposure equipment.

## 1 Installation

The Exposure 2010S Integrated Amplifier : Front View

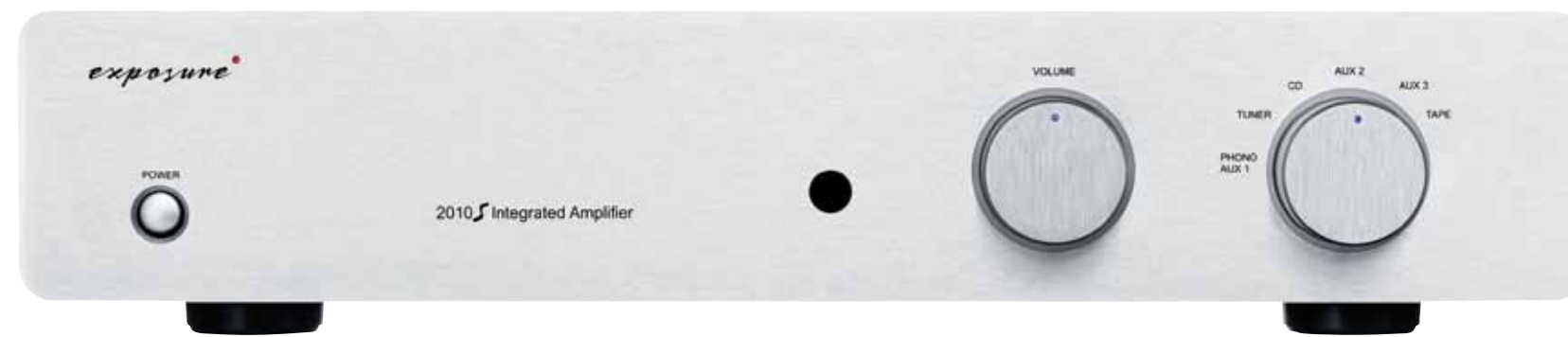

a) Turn volume control to minimum before connecting or disconnecting any cables.



b) Connect the mains cable to the IEC mains input socket.



c) Connect to the mains outlet on the wall. DO NOT switch on until all input and output connections are made.

## 2 CD Player/Tuner/Tape/DVD/etc Connections

The Exposure 2010S Integrated Amplifier is fitted with six-line level RCA Phono inputs, suitable for connection of CD players, tuners, recorders, DVD players and other source components.

The Exposure 2010S Integrated Amplifier: Back View



### Input

a) Connect RCA Phono cables from source components (CD Player/Tuner/Tape/DVD/etc) to the respective inputs.

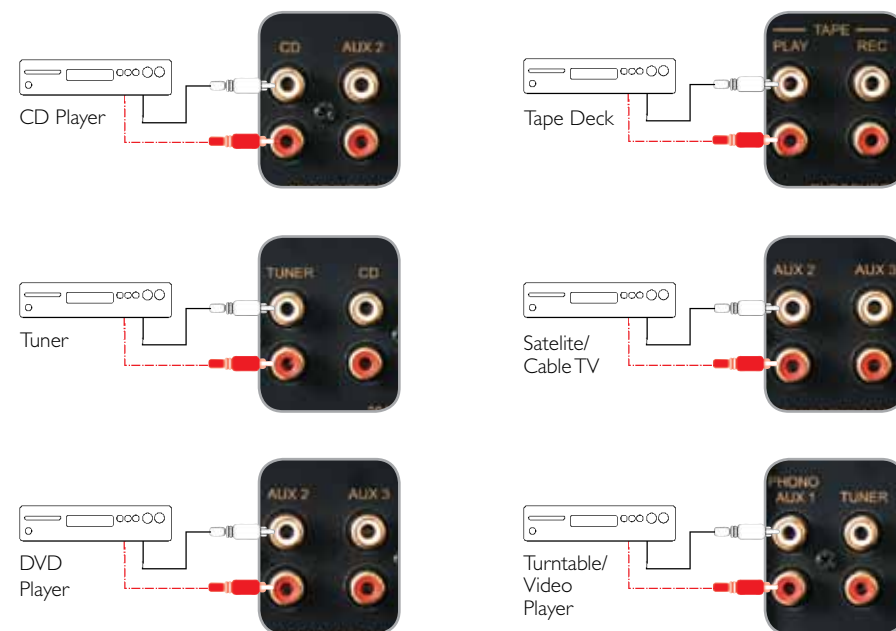

b) Ensure left and right channels are connected correctly. (Right channel is marked in red)

c) The tape input is labeled TAPE PLAY.

Turntable connection requires the installation of an optional MM or MC Phono Card. A ground terminal is provided for connection to a turntable arm grounding wire or RCA ground wire only.

### Output

**TAPE REC** provides line level output signals for recording.

**PRE OUT** provides left and right channel output signals appropriate for connection to an Exposure 2010S Power Amplifier (a future-proof upgrade).

## 3 Loudspeaker Connections

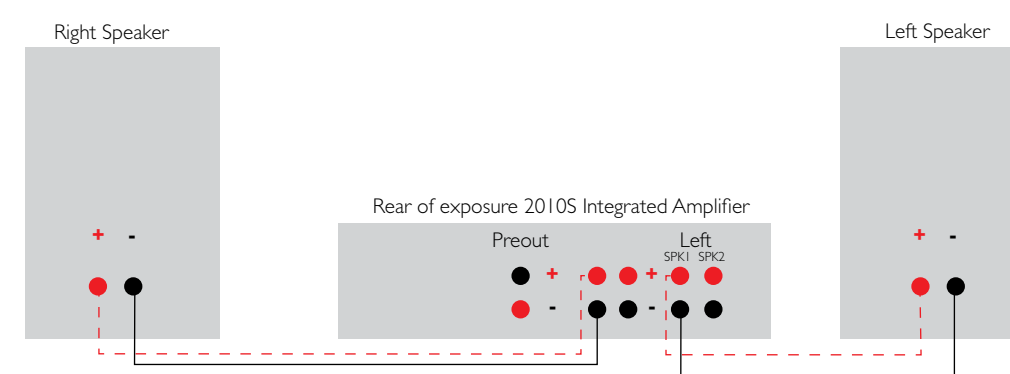

- Connect left and right loudspeakers to corresponding left and right speaker outputs on the amplifier.
- Connect (+) terminal of loudspeaker to (+) terminal of the amplifier.
- Connect (-) terminal of loudspeaker to (-) terminal of the amplifier.

### Bi-wired connection

Bi-wiring may provide a useful gain in subjective performance. Should you choose this option, please refer to the "Extended Set-Up" instructions overleaf.

### Bi-amping of Loudspeakers

Bi-amping of loudspeakers using a 2010S Integrated and a 2010S Power Amplifier provides a useful gain in subjective performance. For this operation, please refer to the "Extended Set-Up" instructions overleaf.

## 4 Operation



a) Turn amplifier volume control to minimum.



b) Press power switch. The LED power indicator will light up. The pre-amplifier output relay will click after a 6-second delay, together with the other indicator lights on Volume and Input Selector Knobs.



c) Without playing any CD/Tape/DVD/etc, turn the volume control knob slowly clockwise to around 20%. It is normal to hear a faint hiss.



d) Turn the source selection knob to select a live source component (Phono Aux1/Tuner/CD/Aux2/Aux3/Tape). Audio should now be heard when the source component is played.

## 5 Remote Control

The source selection knobs will rotate to match selections made on remote control.



### Grey Buttons

Select the functions of the Exposure CD player (if any).

### Red Button

Mutes the volume output to minimum. Indicator lights on VOLUME and INPUT SELECTOR knobs will be turned off. Press the red button again or press the VOL + button to return volume to its previous level and restore indicator lights.

### Green Buttons

Increase/decrease the volume. Indicator light on VOLUME knob will flash as volume is adjusted.

### Black Buttons

Select input sources. Indicator light on the INPUT SELECTOR knob will flash as sources are selected.

### Installation of a MC or MM Phono Module.

For details, please refer to the "Extended Set-Up" section overleaf or contact your dealer.

# Exposure 2010S Integrated Amplifier Extended Set-Up

## Bi-wiring

The Exposure 2010S Integrated Amplifier is fitted with two sets of 4mm loudspeaker sockets for bi-wired connection. Another pair of speaker wires is required for this operation.

1. Ensure that the links at the speaker terminals between the high frequency and the low frequency are removed on both loudspeakers.
2. Follow the diagram on the right for connecting a pair of loudspeakers in bi-wiring mode.

Please refer to the manufacturer of your loudspeakers for advice on the practicality and potential benefits of bi-wiring.

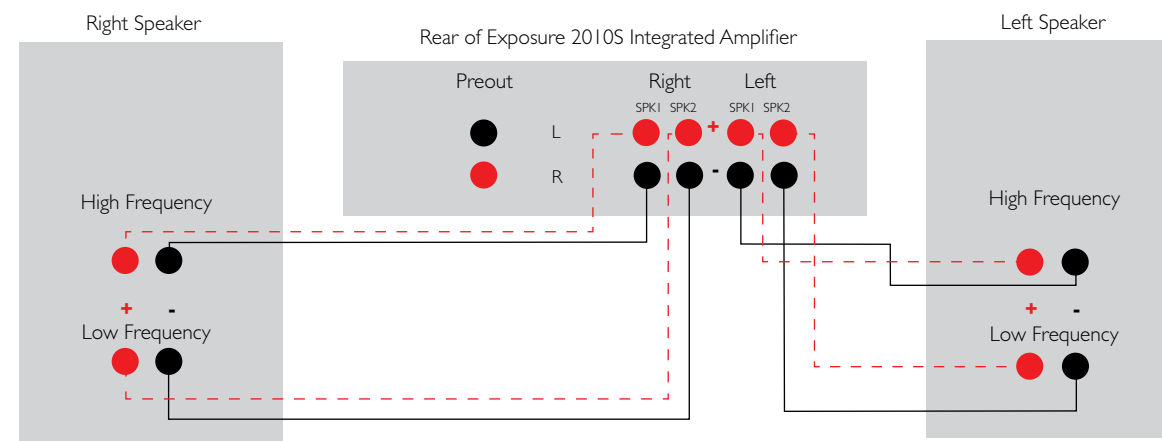

Connecting a pair of loudspeakers in bi-wiring mode

## Bi-amping of Loudspeakers

Bi-amping of suitable loudspeakers using a 2010S Integrated and a 2010S Power Amplifier provides a useful gain in subjective performance. The Integrated Amplifier is used to drive the treble units and the Power Amplifier is used to drive the bass units through the loudspeakers split crossover with the joining links removed.

1. Check your loudspeaker user manual for the wiring connections.
2. Follow the diagram on the right for connecting a pair of loudspeakers in bi-amping mode.

Although the Exposure 2010S Integrated Amplifier is able to drive almost any loudspeaker system, the best results will most likely be achieved with speakers rated at 8 Ohms.

While the Exposure 2010S Integrated Amplifier is compatible with most types of loudspeaker cables, the type of cables used can influence the subjective performance of your system.

Please ask your Exposure dealer for advice on bi-amping, loudspeaker cable compatibility and how to get the best from your Exposure 2010S Integrated Amplifier.

Note: Exposure 2010S Integrated Amplifier is internally protected against damage from short circuits. However, no such protection is infallible, and damage may occur if positive and negative speaker cables are inadvertently connected together.

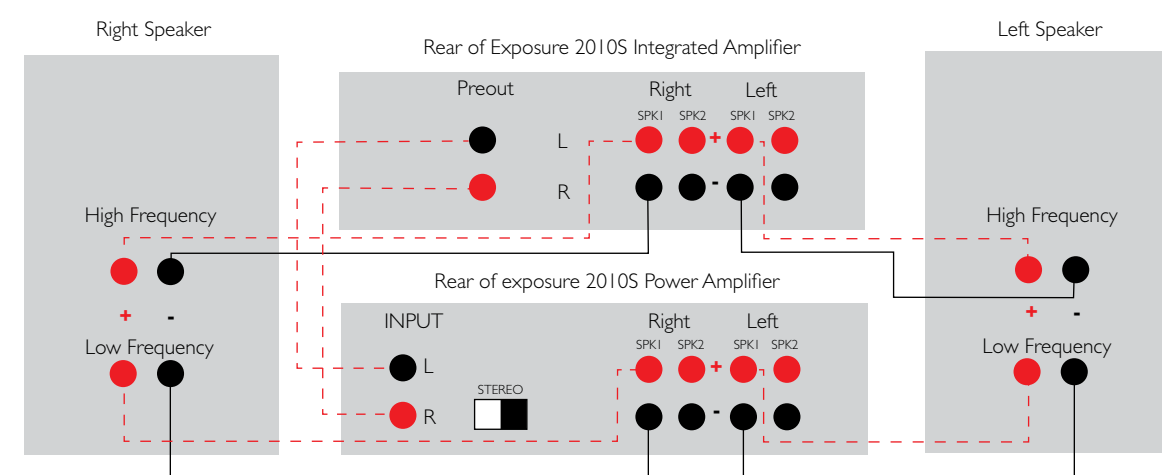

Connecting a pair of loudspeakers in bi-amping mode

## Installation of a MC or MM Phono Module

This is best carried out by your dealer. However, if you wish to attempt installation yourself:



1 Switch off the unit.



2 Remove the mains lead from the wall and the IEC socket.



3 Remove the four cover screws.



4 Slide the cover back about 2 cm until it is free to move upwards to reveal the main circuit board.

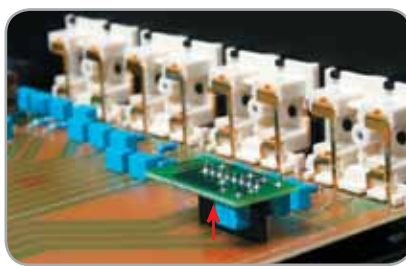

5 Remove the small jumper board that is fitted on the right hand side at the back.

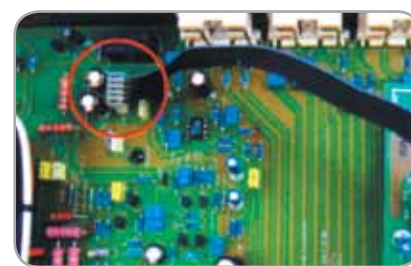

6 Observe the position of the plug on the phono module and carefully plug it in, ensuring that all of the pins are inserted correctly into their connectors.

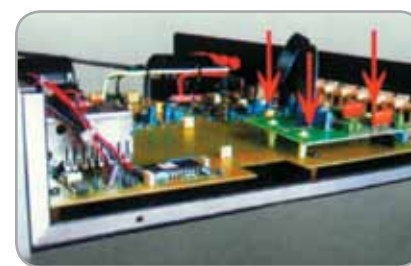

7 Push the three plastic mounting pillars into the corresponding holes in the main board.



8 Replace the cover and screws.

## Safety

Incorrect installation or inappropriate use of the Exposure 2010S Integrated Amplifier may result in injury due to electric shock.

- Ensure that the voltage rating on the rear panel of this unit matches that of your local mains supply.\*
  - Ensure that the mains cable and plug supplied with this unit is also correct. (Contact your dealer immediately if this is not the case.)
  - This unit is protected by a mains fuse which is accessible as part of the IEC socket on the rear panel.
  - Fuse replacement specifications:  
220/240V units T2A fuse  
110/120V units T4A fuse
  - Protect unit against all forms of liquid. Never expose unit to dripping or splashing, or place objects filled with water, such as vases, on the unit.
  - Unplug unit from mains when not in use for prolonged periods.
  - Do not open this unit-there are NO user serviceable parts inside (except to install or change a phono card).
  - Reduce the volume control to minimum before turning this unit on or off.
  - Ensure that this unit is switched off when connecting or disconnecting speaker and interconnect cables.
- \* **Contact Exposure Electronics for advice on moving your equipment to another country or territory.**

## Caution

For a long and trouble-free life of your Exposure 2010S Integrated Amplifier, please ensure the following:

- Do not short circuit the speaker terminals.
- Do not remove the cover of the Integrated Amplifier or dismantle the case (except to install or change phono card).
- Protect unit against all forms of liquid. Never expose unit to dripping or splashing, or place objects filled with water, such as vases, on the unit.
- Do not operate the Integrated Amplifier in damp environment or allow liquids to enter the unit.
- Do not attempt to bypass the mains fuse or replace the fuse with one of a different specification.
- Do not place the Integrated Amplifier in a position which restricts cooling airflow around its case.
- Do not use abrasive or solvent-based cleaning fluids on the Integrated Amplifier's case.

Failure to observe these precautionary measures may void your warranty.

## Technical Specifications

Power Output (1KHz):	75 Watts per channel RMS 8 Ohms
Input Sensitivity:	250mV
Input Impedance:	>14K Ohms, line input
Pre-amplifier Output:	gain + 18dB
Frequency Response:	20Hz – 20KHz ± 0.5dB
Total Harmonic Distortion:	<0.05% at 1KHz, rated power
Signal to Noise:	>100dB, A weighted, ref rated output
Channel Separation:	20Hz - 20KHz, >60dB
Mains Supply:	110/120V or 220/240V, 50/60Hz (factory set)
Max Power Consumption:	200VA (both channels driven, 8 Ohms load)
Dimensions (H x W x D):	90 mm x 440 mm x 310 mm
Nett Weight (Unpacked):	7 kg
Gross Weight (Packed):	9 kg

## Exposure Warranty Policy

1. The Exposure warranty entitles you to FREE repair of this unit for the first three (3) years from the date of purchase.
2. This warranty is valid only if the unit is purchased from an authorised Exposure dealer, registered with the authorised agent in your country of residence and issued with a recognised warranty card.
3. The agent accepts no responsibility for defects arising from accident, misuse, abuse, wear and tear, neglect or through unauthorised adjustment and/or repair or replacement of any components, nor will they accept responsibility for damage or loss occurring during transit to or from the person making a claim under warranty.
4. The Exposure warranty covers:
  - Parts and labour costs for three (3) years from the date of purchase. Please retain your original receipt as proof of purchase and purchase date. The guarantee is extended only to the original purchaser and is not transferable.

### When making claims under this warranty:

1. The equipment should be suitably packed and returned to the dealer from whom it was purchased, or directly to the local distributor, together with proof of purchase or a copy of the dated sales receipt.
2. If necessary the unit should be sent carriage pre-paid by a reputable carrier - NOT by post.
3. No responsibility is accepted for the unit whilst in transit to the dealer or agent, and customers are advised to insure the unit against loss or damage whilst in transit.
4. The warranty card MUST be produced when making claims against this guarantee.
5. Any tampering or alteration made to the warranty card or to the serial number on the equipment will invalidate the warranty.
6. The dealer or the agent shall notify the customer when the repairs have been completed. The customer must claim the goods within fourteen days from the date of notice, failing which; the Company reserves the right to impose storage charges.
7. The Company reserves the right to dispose of the equipment after 90 days from the date of notice in a manner that it sees fit without compensation to the customer.